

Catálogo de Produtos

Desde 1985 » Simples. Previsível. Rentável



IMPLANTES



Cavidade Conectora de 3.0mm

Integra-CP®

Nº DO PROD.	DIÂMETRO	COMPRIMENTO
345-306	4.5mm	6.0mm
345-308	4.5mm	8.0mm
345-311	4.5mm	11.0mm
350-305	5.0mm	5.0mm
350-306	5.0mm	6.0mm
350-308	5.0mm	8.0mm
350-311	5.0mm	11.0mm
360-305	6.0mm	5.0mm
360-357	6.0mm	5.7mm
360-108	6.0mm	8.0mm



Cavidade Conectora de 2.5mm

Integra-CP®

Nº DO PROD.	DIÂMETRO	COMPRIMENTO
340-255	4.0mm	5.0mm
340-258	4.0mm	8.0mm
340-251	4.0mm	11.0mm
345-258	4.5mm	8.0mm
345-251	4.5mm	11.0mm



Cavidade Conectora de 2.0mm

Integra-CP®

Nº DO PROD.	DIÂMETRO	COMPRIMENTO
330-208	3.0mm	8.0mm
335-008	3.5mm	8.0mm
335-011	3.5mm	11.0mm
340-008	4.0mm	8.0mm
340-011	4.0mm	11.0mm

PLUGUE DE CICATRIZAÇÃO E INSERÇÃO



Nº DO PROD.	DIÂMETRO
100-002	2.0mm
100-025	2.5mm
100-001	3.0mm

COMPONENTES DE MOLDAGEM A NÍVEL DE IMPLANTE



Pilar de Moldagem de Titânio

Pilar de 3.0mm



Munhão Plástico de Moldagem



Análogo do Implante de Titânio

Nº DO PROD.	DESCRIÇÃO
100-433	Pilar e Munhão de Moldagem*
100-434	Kit de Moldagem ao Nível do Implante**
100-435	Munhão de Moldagem (4)
100-388	Análogo do Implante (2)



Pilar de Moldagem de Titânio

Pilar de 2.5mm



Munhão Plástico de Moldagem



Análogo do Implante de Titânio

Nº DO PROD.	DESCRIÇÃO
100-413	Pilar e Munhão de Moldagem*
100-414	Kit de Moldagem ao Nível do Implante**
100-415	Munhão de Moldagem (4)
100-288	Análogo do Implante (2)



Pilar de Moldagem de Titânio

Pilar de 2.0mm



Munhão Plástico de Moldagem



Análogo do Implante de Titânio

Nº DO PROD.	DESCRIÇÃO
100-423	Pilar e Munhão de Moldagem*
100-424	Kit de Moldagem ao Nível do Implante**
100-425	Munhão de Moldagem (4)
100-188	Análogo do Implante (2)

* Contém dois pilares de moldagem de titânio e dois munhões plásticos de moldagem.

** Contém um pilar de titânio, dois munhões plásticos de moldagem e um análogo de titânio.

PRODUTOS DE COLÁGENO



Nº DO PROD.	DESCRIÇÃO
509-600	15 x 20mm Membrana
509-300	20 x 30mm Membrana
509-800	30 x 40mm Membrana



Nº DO PROD.	DESCRIÇÃO
509-400	Plugue de Colágeno (10)

SYNTHOGRAFT™



Nº DO PROD.	DESCRIÇÃO	TAMANHO DA PARTÍCULA	TOTAL EM GRAMAS	FRASCOS
400-125	0.25g	Pequena	1.25g	5
400-150	0.5g	Pequena	2.5g	5
400-151	1.0g	Pequena	5.0g	5
400-152	2.0g	Pequena	10.0g	5
400-525	0.25g	Grande	1.25g	5
400-500	0.5g	Grande	2.5g	5
400-501	1.0g	Grande	5.0g	5
400-502	2.0g	Grande	10.0g	5

ABUTMENTS DE CICATRIZAÇÃO



Pilar de 2.0mm

Nº DO PROD.	DIÂMETRO	ALTURA
240-500	4.0mm	5.0mm
240-800	4.0mm	8.0mm
250-500	5.0mm	5.0mm
250-800	5.0mm	8.0mm



Pilar de 2.5mm

240-525	4.0mm	5.0mm
250-525	5.0mm	5.0mm



Pilar de 3.0mm

350-500	5.0mm	5.0mm
350-800	5.0mm	8.0mm
365-500	6.5mm	5.0mm
365-800	6.5mm	8.0mm
375-500	7.5mm	5.0mm

ABUTMENTS DE CICATRIZAÇÃO TRANSITÓRIOS*



Pilar de 2.5mm

250-201	5.0mm	2.0mm
250-211	5.0mm	3.0mm
250-221	5.0mm	4.0mm
250-241	5.0mm	6.0mm

*Cada abutment é embalado com um munhão de 5.0mm para abutment com ombro.

ABUTMENTS TEMPORÁRIOS PARA LEVANTAMENTO DE SEIO



Pilar de 3.0mm

Nº DO PROD.	DIÂMETRO	ALTURA
365-503	6.5mm	2.5mm
370-503	7.0mm	2.5mm



Pilar de 2.5mm

Nº DO PROD.	DIÂMETRO	ALTURA
260-503	6.0mm	2.5mm

ABUTMENTS TEMPORÁRIOS (Ti)



Pilar de 2.0mm

Nº DO PROD.	DIÂMETRO	ALTURA
135-245	3.5mm	4.5mm
135-265	3.5mm	6.5mm
140-245	4.0mm	4.5mm
140-265	4.0mm	6.5mm
150-245	5.0mm	4.5mm
150-265	5.0mm	6.5mm



Pilar de 2.5mm

Nº DO PROD.	DIÂMETRO	ALTURA
240-545	4.0mm	4.5mm
240-565	4.0mm	6.5mm
250-545	5.0mm	4.5mm
250-565	5.0mm	6.5mm
375-345	7.5mm	4.5mm
375-365	7.5mm	6.5mm



Pilar de 3.0mm

Nº DO PROD.	DIÂMETRO	ALTURA
340-345	4.0mm	4.5mm
340-365	4.0mm	6.5mm
350-345	5.0mm	4.5mm
350-365	5.0mm	6.5mm
365-345	6.5mm	4.5mm
365-365	6.5mm	6.5mm

ABUTMENTS TEMPORÁRIOS COM PILAR ESTENDIDO



Pilar de 2.5mm

Nº DO PROD.	DIÂMETRO	ALTURA
240-510	4.0mm	3.0mm
240-520	4.0mm	4.0mm
250-510	5.0mm	3.0mm
250-520	5.0mm	4.0mm
250-540	5.0mm	6.0mm



Pilar de 3.0mm

Nº DO PROD.	DIÂMETRO	ALTURA
350-510	5.0mm	3.0mm
350-520	5.0mm	4.0mm
350-540	5.0mm	6.0mm
365-510	6.5mm	3.0mm
365-520	6.5mm	4.0mm

MUNHÕES EMERGENTES PARA ABUTMENTS SEM OMBRO (4)



Nº DO PROD.	DIÂMETRO
140-010	4.0mm
150-010	5.0mm
165-065	6.5mm

ABUTMENTS SEM OMBRO



Pilar de 2.0mm

Nº DO PROD.	DIÂMETRO	ALTURA	ÂNGULO
135-001	3.5mm	6.5mm	0°
135-015	3.5mm	6.5mm	15°
140-002	4.0mm	6.5mm	0°
140-015	4.0mm	6.5mm	15°
140-025	4.0mm	6.5mm	25°
140-101	4.0mm	10.0mm	0°
140-115	4.0mm	10.0mm	15°
150-050	5.0mm	5.0mm	0°
150-055	5.0mm	5.0mm	15°
150-001	5.0mm	6.5mm	0°
150-015	5.0mm	6.5mm	15°
150-025	5.0mm	6.5mm	25°
150-201	5.0mm	12.0mm	0°
150-215	5.0mm	12.0mm	15°

ABUTMENTS SEM OMBRO



Pilar de 2.5mm

Nº DO PROD.	DIÂMETRO	ALTURA	ÂNGULO
240-001	4.0mm	6.5mm	0°
240-015	4.0mm	6.5mm	15°
240-025	4.0mm	6.5mm	25°
240-101	4.0mm	10.0mm	0°
240-115	4.0mm	10.0mm	15°
250-001	5.0mm	6.5mm	0°
250-015	5.0mm	6.5mm	15°
250-025	5.0mm	6.5mm	25°
250-111	5.0mm	10.0mm	0°
250-115	5.0mm	10.0mm	15°
265-050	6.5mm	5.0mm	0°
265-055	6.5mm	5.0mm	15°



Pilar de 3.0mm

Nº DO PROD.	DIÂMETRO	ALTURA	ÂNGULO
340-001	4.0mm	6.5mm	0°
340-015	4.0mm	6.5mm	15°
340-101	4.0mm	10.0mm	0°
340-115	4.0mm	10.0mm	15°
350-050	5.0mm	5.0mm	0°
350-055	5.0mm	5.0mm	15°
350-001	5.0mm	6.5mm	0°
350-015	5.0mm	6.5mm	15°
350-025	5.0mm	6.5mm	25°
350-101	5.0mm	10.0mm	0°
350-115	5.0mm	10.0mm	15°
350-201	5.0mm	12.0mm	0°
350-215	5.0mm	12.0mm	15°
365-050	6.5mm	5.0mm	0°
365-055	6.5mm	5.0mm	15°
365-001	6.5mm	6.5mm	0°
365-015	6.5mm	6.5mm	15°
375-801	7.5mm	8.0mm	0°
375-815	7.5mm	8.0mm	15°



Pilar ESTENDIDO de 3.0mm

Nº DO PROD.	DIÂMETRO	ALTURA	ÂNGULO
350-150	5.0mm	6.5 x 4.0mm	0°
350-155	5.0mm	6.5 x 4.0mm	15°
350-350	5.0mm	6.5 x 5.5mm	0°
350-355	5.0mm	6.5 x 5.5mm	15°

COMPONENTES PROTÉTICOS PARA ABUTMENTS SEM OMBRO

Kits de Reabilitação e Laboratório*



3.5 x 6.5mm

Nº DO PROD.	DIÂMETRO	COMPRIMENTO
135-465	3.5mm	6.5mm



4.0 x 6.5mm

4.0 x 10mm

140-465	4.0mm	6.5mm
140-410	4.0mm	10.0mm



5.0 x 5.0mm

5.0 x 6.5mm

5.0 x 10mm

5.0 x 12mm

150-450	5.0mm	5.0mm
150-465	5.0mm	6.5mm
150-410	5.0mm	10.0mm
150-412	5.0mm	12.0mm

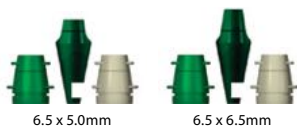

6.5 x 5.0mm

6.5 x 6.5mm

165-450	6.5mm	5.0mm
165-465	6.5mm	6.5mm



7.5 x 8.0mm

175-480	7.5mm	8.0mm
---------	-------	-------

*Cada kit contém (1) transferente, (1) munhão de moldagem/enceramento e (1) munhão de temporização.

Munhões de Temporização (2)



3.5mm

4.0mm

5.0mm

6.5mm

7.5mm

Nº DO PROD.	DIÂMETRO
135-165	3.5mm
140-165	4.0mm
150-165	5.0mm
165-165	6.5mm
175-165	7.5mm

ABUTMENTS COM OMBRO*



Pilar de 2.0mm

Nº DO PROD.	DIÂMETRO	ALTURA	ÂNGULO
200-150	3.5mm	1.5mm	0°
200-200	4.0mm	1.5mm	0°
200-400	4.0mm	3.5mm	0°
200-201	5.0mm	2.0mm	0°
200-202	5.0mm	2.0mm	10°
200-221	5.0mm	4.0mm	0°
200-222	5.0mm	4.0mm	10°
200-241	5.0mm	6.0mm	0°
200-242	5.0mm	6.0mm	10°



Pilar de 2.5mm

250-300	4.0mm	1.5mm	0°
250-400	4.0mm	3.5mm	0°
250-301	5.0mm	2.0mm	0°
250-302	5.0mm	2.0mm	10°
250-311	5.0mm	3.0mm	0°
250-312	5.0mm	3.0mm	10°
250-321	5.0mm	4.0mm	0°
250-322	5.0mm	4.0mm	10°
250-341	5.0mm	6.0mm	0°
250-342	5.0mm	6.0mm	10°



Pilar de 3.0mm

300-300	4.0mm	1.5mm	0°
300-400	4.0mm	3.5mm	0°
300-301	5.0mm	2.0mm	0°
300-302	5.0mm	2.0mm	10°
300-311	5.0mm	3.0mm	0°
300-312	5.0mm	3.0mm	10°
300-321	5.0mm	4.0mm	0°
300-322	5.0mm	4.0mm	10°
300-341	5.0mm	6.0mm	0°
300-342	5.0mm	6.0mm	10°
300-361	5.0mm	8.0mm	0°
300-601	6.5mm	2.0mm	0°
300-602	6.5mm	2.0mm	10°
300-621	6.5mm	4.0mm	0°
300-622	6.5mm	4.0mm	10°

*Cada abutment é embalado com dois munhões com ombro correspondentes.

COMPONENTES PROTÉTICOS PARA ABUTMENTS COM OMBRO

Munhões para Abutments com Ombro (4)



4.0mm

5.0mm

6.5mm

Nº DO PROD.	DIÂMETRO
250-204	4.0mm
250-205	5.0mm
250-206	6.5mm



4.0mm

5.0mm

6.5mm

250-004	4.0mm Curto
250-005	5.0mm Curto
250-006	6.5mm Curto



3.5mm

4.0mm

5.0mm

6.5mm

250-103	3.5mm Alta
250-104	4.0mm Alta
250-105	5.0mm Alta
250-106	6.5mm Alta

Análogos do Abutment com Ombro (2)

METAL

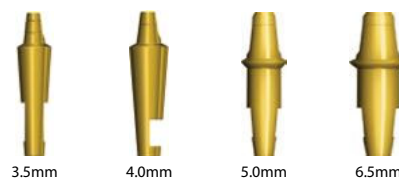

3.5mm

4.0mm

5.0mm

6.5mm

Nº DO PROD.	DIÂMETRO
250-183	3.5mm
250-184	4.0mm
250-185	5.0mm
250-186	6.5mm

Munhões de Óxido de Alumínio*

Al₂O₃



3.5 x 7.0mm

4.0 x 7.0mm

5.0 x 7.0mm

5.0 x 10.0mm

Nº DO PROD.	DIÂMETRO	ALTURA
250-371	3.5mm	7.0mm
250-471	4.0mm	7.0mm
250-571	5.0mm	7.0mm
250-101	5.0mm	10.0mm

*Embalado com o transfer correspondente.

ABUTMENTS BREVIS™*



Pilar de 2.0mm

Nº DO PROD.	ALTURA	ÂNGULO
100-404	2.0mm	0°
100-405	2.0mm	15°
100-406	4.0mm	0°
100-407	4.0mm	15°
100-408	6.0mm	0°
100-409	6.0mm	15°



Pilar de 2.5mm

Nº DO PROD.	ALTURA	ÂNGULO
250-424	2.0mm	0°
250-425	2.0mm	15°
250-426	4.0mm	0°
250-427	4.0mm	15°
250-428	6.0mm	0°
250-429	6.0mm	15°



Pilar de 3.0mm

Nº DO PROD.	ALTURA	ÂNGULO
300-434	2.0mm	0°
300-435	2.0mm	15°
300-436	4.0mm	0°
300-437	4.0mm	15°
300-438	6.0mm	0°
300-439	6.0mm	15°

*Cada Abutment é embalado com alojamento de titânio Brevis com o-ring.

COMPONENTES DOS ABUMENTS BREVIS™



O-Rings de Borracha c/ Maior Retenção



O-Rings de Borracha c/ Menor Retenção

Nº DO PROD.	DESCRIÇÃO
100-013	O-Rings - Maior Retenção (10)
100-014	O-Rings - Menor Retenção (10)



O-Ring de Borracha



Alojamento Brevis



Capuz de Moldagem



Transferente de Alumínio

100-212	Alojamento
100-217	Kit de Moldagem com Alojamento
100-218	Kit de Moldagem sem Alojamento

ABUTMENT FIXO-REMÓVEL*



Pilar de 2.0mm

Nº DO PROD.	DIÂMETRO	ALTURA	ÂNGULO
100-003	4.0mm	3.0mm	0°
100-015	4.0mm	3.0mm	15°
100-004	4.0mm	5.0mm	0°
100-115	4.0mm	5.0mm	15°



Pilar de 2.5mm

250-213	4.0mm	3.0mm	0°
250-215	4.0mm	3.0mm	15°
250-214	4.0mm	5.0mm	0°
250-255	4.0mm	5.0mm	15°



Pilar de 3.0mm

300-003	4.0mm	3.0mm	0°
300-015	4.0mm	3.0mm	15°
300-004	4.0mm	5.0mm	0°
300-115	4.0mm	5.0mm	15°

COMPONENTES DO ABUTMENT FIXO-REMÓVEL*



Transferente de Plástico e Coifas de Fundição



Coifas Transferentes de Titânio



Análogos de Abutment em Titânio

Nº DO PROD.	DESCRIÇÃO
100-005	Coifa Plástica (4)
100-019	Coifa de Titânio (4)
100-006	Análogo de Titânio (4)



Parafusos Hexagonais para Coifas de 5.0mm



Parafusos Hexagonais para Coifas de 10.0mm



Parafusos Hexagonais de Retenção



Parafusos Hexagonais de Recobrimento

100-016	Parafusos Hexagonais para Coifas de 5.0mm (4)
100-017	Parafusos Hexagonais para Coifas de 10.0mm (4)
100-020	Parafusos Hexagonais de Retenção (4)
100-021	Parafusos Hexagonais de Recobrimento (4)



101-024	Chave Hexagonal
---------	-----------------

*Para reabilitações retidas por parafusos e de barra.

ABUTMENTS DE LABORATÓRIO*



Pilar de 2.0mm

Nº DO PROD.	DIÂMETRO	ALTURA	ÂNGULO
740-610	4.0mm	4.0mm	0°
740-615	4.0mm	4.0mm	15°



Pilar de 2.5mm

550-600	5.0mm	3.0mm	0°
550-605	5.0mm	3.0mm	15°
550-610	5.0mm	4.0mm	0°
550-615	5.0mm	4.0mm	15°
550-620	5.0mm	5.0mm	0°
550-625	5.0mm	5.0mm	15°

565-600	6.5mm	3.0mm	0°
565-605	6.5mm	3.0mm	15°
565-610	6.5mm	4.0mm	0°
565-615	6.5mm	4.0mm	15°



Pilar de 3.0mm

650-600	5.0mm	3.0mm	0°
650-605	5.0mm	3.0mm	15°
650-610	5.0mm	4.0mm	0°
650-615	5.0mm	4.0mm	15°
650-620	5.0mm	5.0mm	0°
650-625	5.0mm	5.0mm	15°

665-600	6.5mm	3.0mm	0°
665-605	6.5mm	3.0mm	15°
665-610	6.5mm	4.0mm	0°
665-615	6.5mm	4.0mm	15°

*Desenhado para ser preparado para próteses IAC® ou Metalocerâmicas.

MOTOR E CONTRA-ÂNGULOS



Nº DO PROD.	DESCRIÇÃO
028-150	Motor Elétrico
028-425	Cabo para Motor Elétrico



Contra-Ângulo de Alto Torque 20:1



Contra-Ângulo de Baixo Torque 20:1



Contra-Ângulo 400:1

028-201	Contra-Ângulo de Alto Torque 20:1
028-202	Contra-Ângulo de Baixo Torque 20:1
028-401	Contra-Ângulo 400:1



Motor a Ar de 20mil RPM

024-120	Motor a Ar de 20mil RPM Apenas sob encomenda
---------	---

KITS CIRÚRGICOS E REABILITADORES



Kit Cirúrgico Introdutório



Kit Cirúrgico Intermediário



Kit Cirúrgico Avançado



Kit Restaurador

Nº DO PROD.	DESCRIÇÃO
101-057	Introdutório
101-098	Abrangente
101-095	Avançado
101-096	Restaurador

BANDEJA DE INSTRUMENTOS



Avançado Abrangente Restaurador

Nº DO PROD.	DESCRIÇÃO
104-993	Avançado
104-994	Abrangente
104-996	Restaurador

ESCAVADORAS MECÂNICAS PADRÃO (Ti6Al4V)



Nº DO PROD.	DESCRIÇÃO
101-125	2.5mm
101-130	3.0mm
101-135	3.5mm
101-140	4.0mm
101-645	4.5mm
101-650	5.0mm
101-655	5.5mm
101-660	6.0mm
101-120	Jogo de Escavadoras Mecânicas Padrão

ESCAVADORAS MECÂNICAS ESTENDIDAS (Ti6Al4V)



101-325	2.5mm
101-330	3.0mm
101-335	3.5mm
101-340	4.0mm
101-345	4.5mm
101-350	5.0mm
101-355	5.5mm
101-360	6.0mm
101-121	Jogo de Escavadoras Mecânicas Estendidas

ESCAVADORAS MANUAIS (Ti6Al4V)



101-025	2.5mm
101-030	3.0mm
101-035	3.5mm
101-040	4.0mm
101-045	4.5mm
101-050	5.0mm
101-055	5.5mm
101-060	6.0mm
101-122	Kit de Escavadoras Manuais

Inclui colocador reto, extensor da escavadora manual e catraca de remoção.

BROCAS PILOTO (Aço Inoxidável)



Broca Piloto de 2.0mm
Tamanho Padrão

Broca Piloto de 2.0mm
Estendida

Nº DO PROD.	DESCRIÇÃO
101-001	Broca Piloto de 2.0mm Tamanho Padrão
101-002	Broca Piloto de 2.0mm Estendida

CATRACA REMOVEDORA DE ESCAVADORA



101-017	Catraca Removedora de Escavadora
---------	----------------------------------

EXTENSOR



101-022	Extensor da Escavadora Mecânica
---------	---------------------------------

PINOS DE PARALELISMO



0°

701-001	0°
---------	----

MEDIDORES



Medidor de Osteotomia com Dupla Extremidade

Medidor de Altura do Ombro do Abutment

101-370	Medidor de Osteotomia com Dupla Extremidade
101-380	Medidor de Altura do Ombro do Abutment

COMPONENTES ROSQUEÁVEIS



Colocador Reto

Direcionador Angulado

Rosqueador

Adaptador para
Instrumento Rosqueável

Nº DO PROD.	DESCRIÇÃO
101-016	Colocador Reto
101-009	Direcionador Angulado
101-014	Rosqueador
101-020	Adaptador para Instrumento Rosqueável*

Para usar com as Escavadoras de Sulco, Escavadoras Manuais e Punches de Tecido.

PONTAS DE ASSENTAMENTO



2.0mm

2.5mm

3.0mm

101-010	2.0mm
101-258	2.5mm
101-018	3.0mm

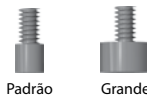

Padrão

Grande

101-012	Padrão
101-019	Grande

COLOCADOR E REMOVEDOR

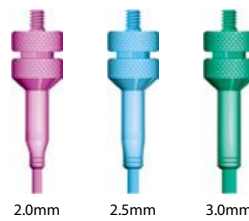

2.0mm

2.5mm

3.0mm

101-005	2.0mm
101-007	2.5mm
101-006	3.0mm

ESCAVADORAS DE SULCO*

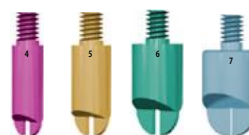

101-440	4 Série
101-450	5 Série
101-465	6 Série
101-475	7 Série

*Embaladas com os Pinos Guia.

PUNCHES DE TECIDO*



3.5mm

4.0mm

5.0mm

6.5mm

Nº DO PROD.	DESCRIÇÃO
101-535	3.5mm
101-540	4.0mm
101-550	5.0mm
101-565	6.5mm

EXPANSORES DE OSSO



901-430	3.0mm
901-435	3.5mm
901-440	4.0mm
901-445	4.5mm
901-450	5.0mm
901-455	5.5mm
901-460	6.0mm
101-123	Jogo de Expansores de Osso

OSTEÓTOMOS



901-535	3.5mm
901-540	4.0mm
901-545	4.5mm
901-550	5.0mm
901-560	6.0mm
101-124	Jogo de Osteótomos

PINOS GUIA

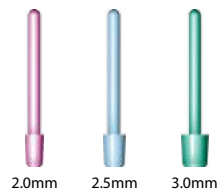

2.0mm

2.5mm

3.0mm

Nº DO PROD.	DESCRIÇÃO
101-180	2.0mm (4)
101-186	2.5mm (4)
101-183	3.0mm (4)

CINZÉIS DE EXPANSÃO



901-613	3.0mm
901-615	5.0mm
901-616	6.0mm

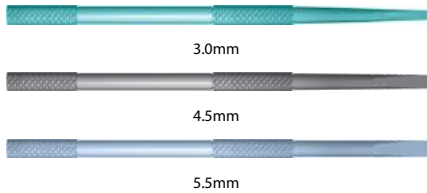

801-330	3.0mm
801-345	4.5mm
801-355	5.5mm

INSTRUMENTAÇÃO PARA ENXERTOS ÓSSEOS



801-510	Seringa para Enxertos Ósseos de 4.0mm
801-511	Seringa para Enxertos Ósseos de 5.0mm

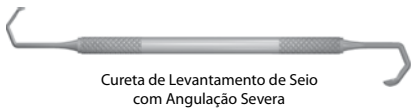

Cureta de Levantamento de Seio com Angulação Severa



Cureta de Levantamento de Seio com Angulação Padrão



Elevador de Antroplastia

801-515	Angulação Severa
801-517	Angulação Padrão
801-518	Elevador de Antroplastia



201-029	Broca de Levantamento de Seio
---------	-------------------------------

TREFINAS

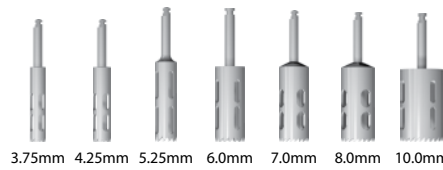

801-837	3.75mm (4.6mm DE)
801-840	4.25mm (5.2mm DE)
801-850	5.25mm (6.2mm DE)
801-860	6.0mm (6.95mm DE)
801-870	7.0mm (7.95mm DE)
801-880	8.0mm (8.95mm DE)
801-810	10.0mm (11.0mm DE)

CURETAS



Cureta Reta



Cureta Angulada

801-520	Cureta Reta
801-522	Cureta Angulada

INTENSIFICADOR DE COR



103-006	Intensificador de Cor Bicon
---------	-----------------------------

POTE DAPPEN DE SILICONE



103-030	Pote Dappen de Silicone
---------	-------------------------

MARTELO



801-165	Martelo
---------	---------

PERIÓTOMOS



Periótomo Reto com Dupla Terminação



Periótomo Angulado com Dupla Terminação

Nº DO PROD.	DESCRIÇÃO
801-007	Reto com Dupla Terminação
801-008	Angulado com Dupla Terminação

GRADE RADIOGRÁFICA

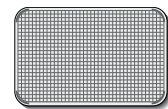

103-002	30 x 42mm
---------	-----------

HASTES APLICADORAS DE ALGODÃO



Hastes Aplicadoras de Algodão de 2.0mm (100)



Hastes Aplicadoras de Algodão de 3.0mm (100)

103-027	2.0mm (100)
103-028	3.0mm (100)

PREPARO DO ABUTMENT



Segurador Preparador com Pontas



Ponta de 2.0mm



Ponta de 2.5mm

101-395	Segurador Preparador com Pontas
701-382	Ponta de 2.0mm
701-385	Ponta de 2.5mm

DISPOSITIVO DE ALINHAMENTO DE COROA



Dispositivo de Alinhamento de Coroa



Ponta Posicionadora de Coroa

Nº DO PROD.	DESCRIÇÃO
101-315	Dispositivo de Alinhamento de Coroa
101-015	Ponta Posicionadora de Coroa

INSTRUMENTOS PARA O PLUGUE DE CICATRIZAÇÃO



Cortador do Plugue de Cicatrização



Instrumento de Remoção do Plugue de Cicatrização (Manual)



Instrumento de Remoção do Plugue de Cicatrização (Mecânico)

801-001	Cortador do Plugue de Cicatrização
101-114	Instrumento de Remoção (Manual)
101-115	Instrumento de Remoção (Mecânico)

FÓRCEPS DE ABUTMENT



Fórceps Carregador de Abutment



Fórceps Removedor de Abutment (Superior)



Fórceps Removedor de Abutment (Inferior)

801-002	Fórceps Carregador
801-050	Fórceps Removedor (Superior)
801-051	Fórceps Removedor (Inferior)

BROCAS



Broca 1557 Tamanho Padrão (5)



Broca de Preparo do Abutment 11.0mm



Broca Esférica 4 (5)

Nº DO PROD.	DESCRIÇÃO
155-701	Broca 1557 Tamanho Padrão (5)
201-011	Broca de Preparo do Abutment 11.0mm
155-704	Broca Esférica 4 (5)

RESINA HIDROPLÁSTICA



103-031 Resina Hidroplástica (20g)

MODELOS DE DEMONSTRAÇÃO



Modelo de Resina para Treinamento



Modelo de Coroa



Modelo de Sobredentadura

102-104	Modelo de Resina para Treinamento
102-115	Modelo de Coroa (sob encomenda)
102-120	Modelo de Sobredentadura (sob encomenda)



Réplica do Abutment



Réplica do Implante

102-501	Réplica do Abutment 5.0 x 6.5mm (sob encomenda)
102-508	Réplica do Implante 5.0 x 6.0mm (sob encomenda)

COMPONENTES TRINIA™



Blocos Trinia™



Discos Trinia™

NO. DE PROD.	BLOCO
607-295	20 x 19 x 15mm para Cerec™
607-495	40 x 19 x 15mm para Cerec™
607-595	55 x 19 x 15mm para Cerec™
607-622	65 x 25 x 22mm para Cerec™
607-642	65 x 40 x 22mm para Cerec™
607-842	85 x 40 x 22mm para Cerec™
606-420	42 x 20 x 16mm para Kavo™
606-422	42 x 20 x 20mm para Kavo™
606-625	60 x 20 x 25mm para Kavo™

NO. DE PROD.	DISCO
609-814	98 x 14mm
609-816	98 x 16mm
609-818	98 x 18mm
609-820	98 x 20mm
609-822	98 x 22mm
609-825	98 x 25mm
609-830	98 x 30mm

COMPONENTES PARA IAC®



Kit de Polimento



Forno de Polimerização

NO. DE PROD.	DESCRIÇÃO
103-033	Kit de Polimento para IAC®
499-110	Forno de Polimerização de IAC® -110 volt (sob encomenda)
499-220	Forno de Polimerização (multivoltagem)
018-102	Lâmpada (sob encomenda)

DUPLICADOR DE DENTADURA



103-980	Duplicador de Dentadura
103-990	Kit Duplicador de Dentadura Consiste de um duplicador de dentadura, spray de silicone e Resina Acrílica Ortho-Jet™. Disponível somente nos EUA via transporte terrestre.

Abutment Temporário	Abutment Cicatrizador	Abutment Temporário com Poste Estendido	Abutment de Laboratório
---------------------	-----------------------	---	-------------------------

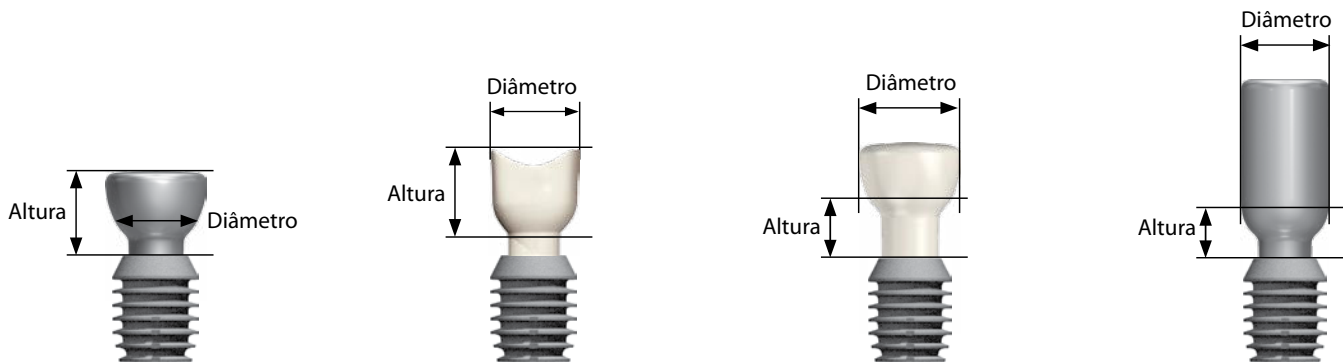

Abutment Sem Ombro

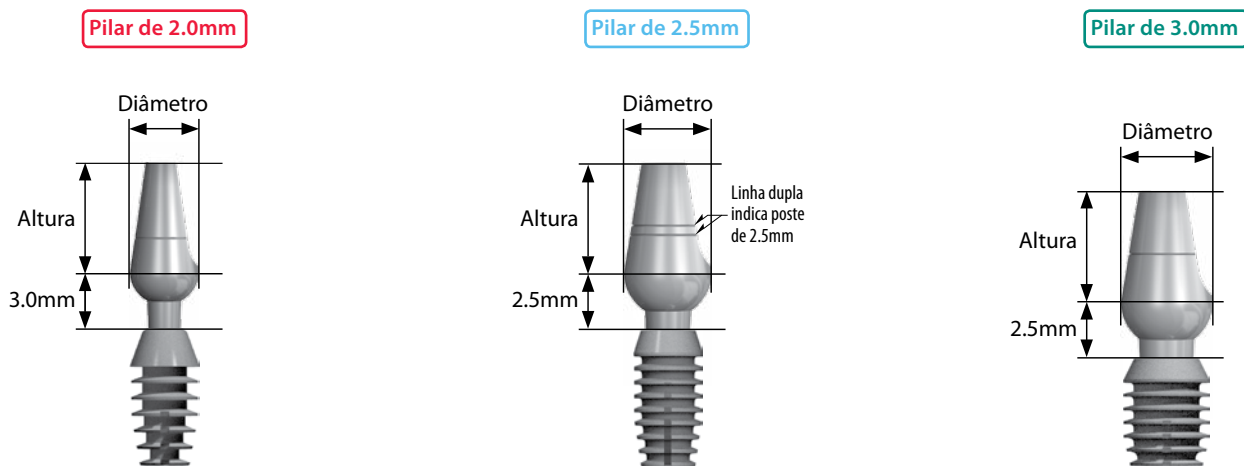

Abutment com Ombro	Abutment Fixo-Removível	Abutment Brevis™
--------------------	-------------------------	------------------

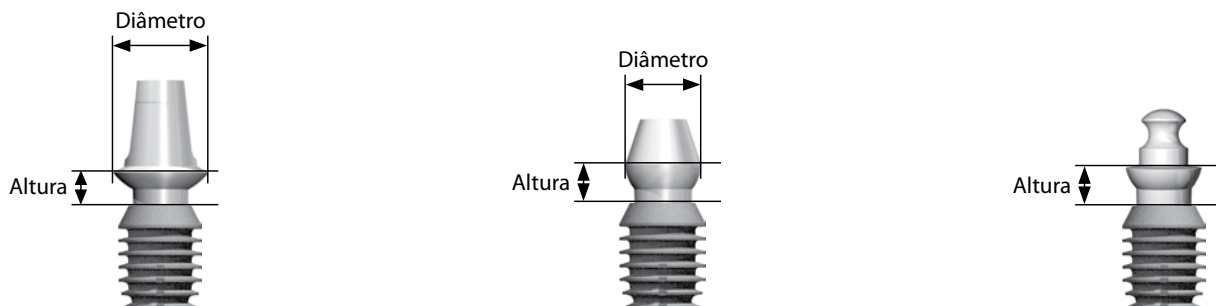





Matriz Mundial

bicon[®]
DENTAL IMPLANTS

BICON BRASIL

Avenida Ibirapuera

2907 CJs: 314, 315 e 316

São Paulo, SP 04029-200

TEL 11-2506-5520

FAX 11-2506-5530

www.bicon.com.br ■ bicon@bicon.com.br